

FITTING INSTRUCTION

Clamp mark in acc. with		Cables joining
ISO	PN	
1	L	Left directional lights
2	+	Rear fog lights
3	31	Ground
4	R	Right directional lights
5	58R	Right side parking lights
6	54	Stoplights
7	58L	Left side parking lights

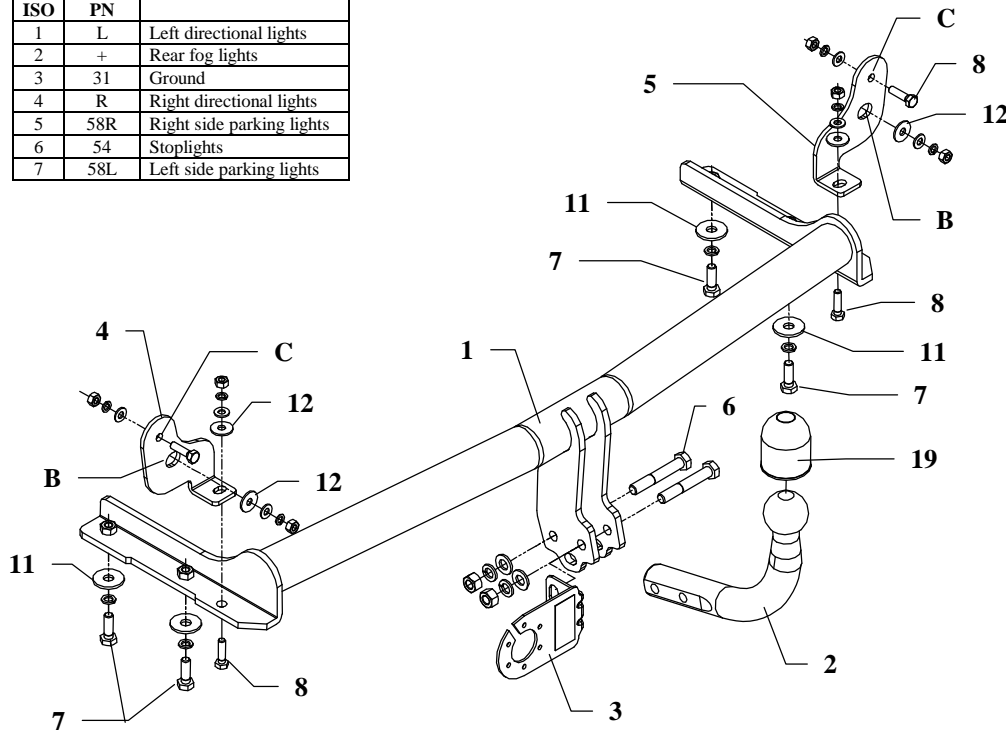

This towbar is designed to assembly in following car:
VOLKSWAGEN POLO 3-5 door, produced since 09.1999 till 12.2001 catalogue number **K30** and is prepared to tow trailers max total weight **1200 kg** and max vertical load **50 kg**.

From manufacturer

Thank you for buying our product. This towbar is design according to rules of safety traffic regulations and their reliability has been confirmed in many tests. Reliability of towbar also depends on correct assembly and correct exploitation. For this reasons we kindly ask to read carefully this instructions and apply to hints.

The towbar should be install in places described by car producer.

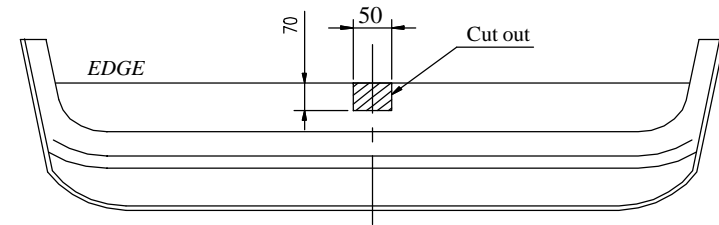

Fig. 2

The instruction of the assembly

1. Disassemble the bumper and metal reinforcement (reinforcement will be not used any more).
2. In bottom part of the bumper cut out the hole as show in the fig. 2
3. From frame holes remove the stickers. Through this holes will be fix the towbar.
4. Put bar of the towbar (pos. 1) into the chassis member and fix with bolts M10x30mm (pos. 7), use big washers $\varnothing 35 \times \varnothing 12 \times 3 \text{mm}$ (pos. 11).
5. Put brackets (pos. 4 and 5) to the rear piece and fix it through holes pos. A to the bar of towbar using bolts M8x30mm (pos. 8), use big washers $\varnothing 25 \times \varnothing 9 \times 2 \text{mm}$ (pos. 12).
6. Through holes (pos. B) in brackets (pos. 4 and 5) fix nuts M8 with big washers $\varnothing 25 \times \varnothing 9 \times 2 \text{mm}$. Take care at the torque moment - **10 Nm**.
7. Through holes (pos. C) in brackets (pos. 4 and 5) make holes with drill $\varnothing 9 \text{mm}$, and next fix with bolts M8x30mm (pos. 8).
8. Fix tow-ball (pos. 2) and socket plate (pos. 3) by bolts M12x75mm (pos. 6) from accessories.
9. Screw tight all bolts according to the torque shown in the table.
10. Connect the electric wires according to the instructions of the car. (Recommended to make at service station)
11. Complete paint layer damaged during installation.

Torque settings for nuts and bolts 8,8 :

M8	25 Nm	M10	55 Nm
M12	85 Nm	M14	135 Nm











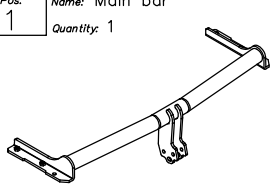
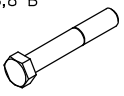





NOTE

After install the tow hook you should get adequate registration in registration book (at authorised service station).The car should be equipment with:

- indicators
- tow mirrors

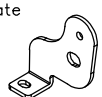
After 1000km of exploitation check all bolts and nuts. The ball of towbar must be always keep clear and conserve with a grease.

Towbar accessories:

Pos. 1	Name: Main bar Quantity: 1	Pos. 6	Name: Bolt 8,8 B Quantity: 2 Dim. : M12x75mm	Pos. 13	Name: Plain washer Quantity: 2 Dim. : \varnothing 13 mm
					
		Pos. 7	Name: Bolt 8,8 B Quantity: 4 Dim. : M10x35mm	Pos. 14	Name: Plain washer Quantity: 4 Dim. : \varnothing 10,5 mm
					
Pos. 2	Name: Tow ball Quantity: 1	Pos. 8	Name: Bolt 8,8 B Quantity: 4 Dim. : M8x30mm	Pos. 15	Name: Plain washer Quantity: 6 Dim. : \varnothing 8,5 mm
					
Pos. 3	Name: Socket plate Quantity: 1	Pos. 9	Name: Nut 8 B Quantity: 2 Dim. : M12	Pos. 16	Name: Spring washer Quantity: 2 Dim. : \varnothing 12,2 mm
					
Pos. 4	Name: Left plate Quantity: 1	Pos. 10	Name: Nut 8 B Quantity: 6 Dim. : M8	Pos. 17	Name: Spring washer Quantity: 4 Dim. : \varnothing 10,2 mm
					
Pos. 5	Name: Right plate Quantity: 1	Pos. 11	Name: Washer Quantity: 4 Dim. : \varnothing 35x \varnothing 12x3mm	Pos. 18	Name: Spring washer Quantity: 6 Dim. : \varnothing 8,2 mm
					
		Pos. 12	Name: Washer Quantity: 4 Dim. : \varnothing 25x \varnothing 9x2mm	Pos. 19	Name: Ball cover Quantity: 1
					



PPUH AUTO-HAK S. J.

Produkcja Zaczepów Kulowych
Henryk & Zbigniew Nejman
76-200 SŁUPSK ul. Słoneczna 16K
tel/fax (059) 8-414-414; 8-414-413
E-mail: office@autohak.com.pl
www.autohak.com.pl

Towing hitch (without electrical set)

Class: **A50-X** Cat. no. **K30**

Designed for:

Manufacturer: **VOLKSWAGEN**

Model: **POLO**

Type: **3/5 door**

produced since 09.1999 till 12.2001

Technical data:

D-value: 6,48 kN

maximum trailer weight: **1200 kg**

maximum vertical cup load: **50 kg**

Approval number acc. to regulations EKG/ONZ 55.01: E20-55R-01 0940

Foreword

This towbar is designed according to rules of safety traffic regulations. The towing hitch is a safety component and can be install only by qualified personnel. Any alteration or conversion of the towing hitch is prohibited and would lead to cancellation of design certification. Remove insulating compound and underseal from vehicle (if present) in the area of the matting surfaces of the towing hitch.

The vehicle manufacturer's specifications regarding trailer load and max. vertical cup load are decisive for driving, and values for the towing hitch cannot be exceeded.

D-value formula:

$$\frac{\text{Max trailer weight [kg]} \times \text{Max vehicle weight [kg]}}{\text{Max trailer weight [kg]} + \text{Max vehicle weight [kg]}} \times \frac{9,81}{1000} = D \text{ [kN]}$$